

# Maxx™ Clam

**28x38 cm • 38x38 cm • 40x50 cm**

## OPERATOR'S MANUAL



## Important Safety Instructions

WHEN USING YOUR APPLIANCE, BASIC PRE-CAUTIONS SHOULD ALWAYS BE FOLLOWED, INCLUDING THE FOLLOWING:

Read all instructions.

Use appliance only for its intended use.

To reduce the risk of electric shock, do not immerse the appliance in water or other liquids.

Never pull cord to disconnect from outlet, instead grasp plug and pull to disconnect.

Do not allow cord to touch hot surfaces, let appliance cool completely before putting away.

Do not operate appliance with a damaged cord, or if the appliance has been dropped or damaged. To reduce the risk of electric shock, do not disassemble or attempt to repair the appliance, take it to a qualified service person for examination and repair. Incorrect reassembly or repair could cause a risk of fire, electric shock, or injury to persons when the appliance is used.

Close supervision is necessary for any appliance being used by or near children.  
Do not leave appliance unattended while connected.

Burns could occur from touching hot metal parts.

To reduce the likelihood of circuit overload, do not operate another high voltage appliance on the same circuit.

If an extension cord is absolutely necessary, a 20 ampere rated cord should be used. Cords rated for less amperage may overheat, care should be taken to arrange the cord so that the cord cannot be pulled or tripped over.

**SAVE THESE INSTRUCTIONS.**

Digital Part Location Guide	3
Maxx™ Clam Control Panel	4
Operating Instructions	5-9
Parts Location Guide	10
Parts List	11
Maxx™ Clam electrical Schematic	12
CE-Certification	13
Terms of guarantee	14

## SIDE VIEW



## FRONT VIEW

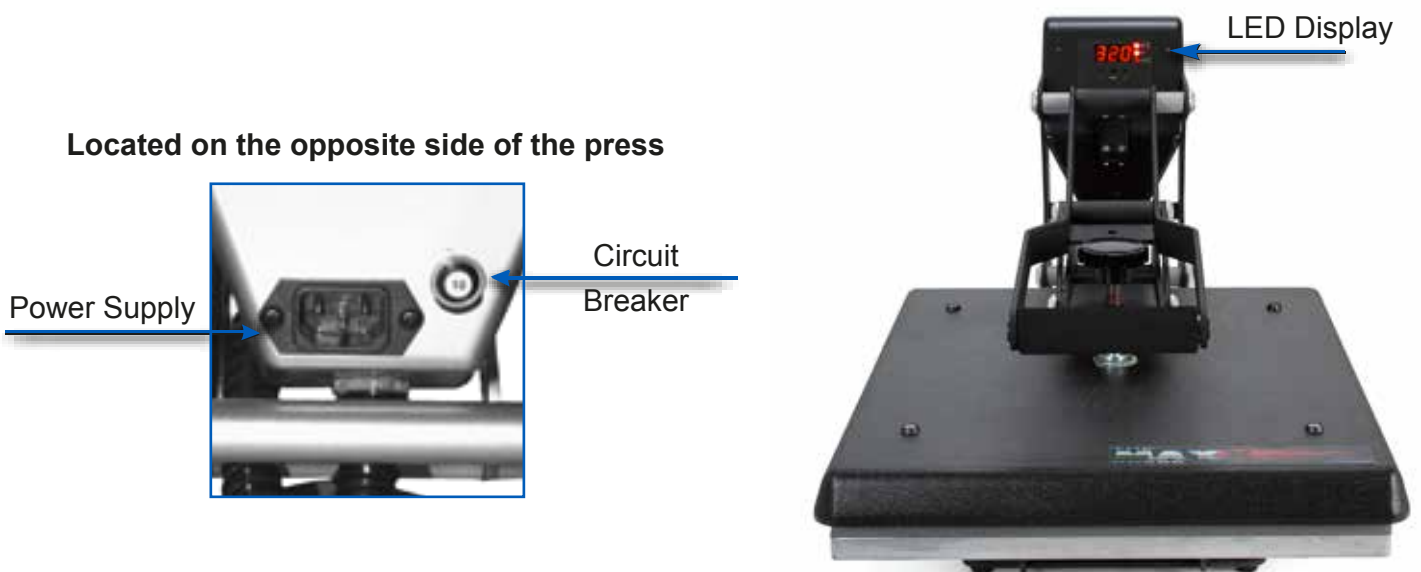

## CONTROL PANEL

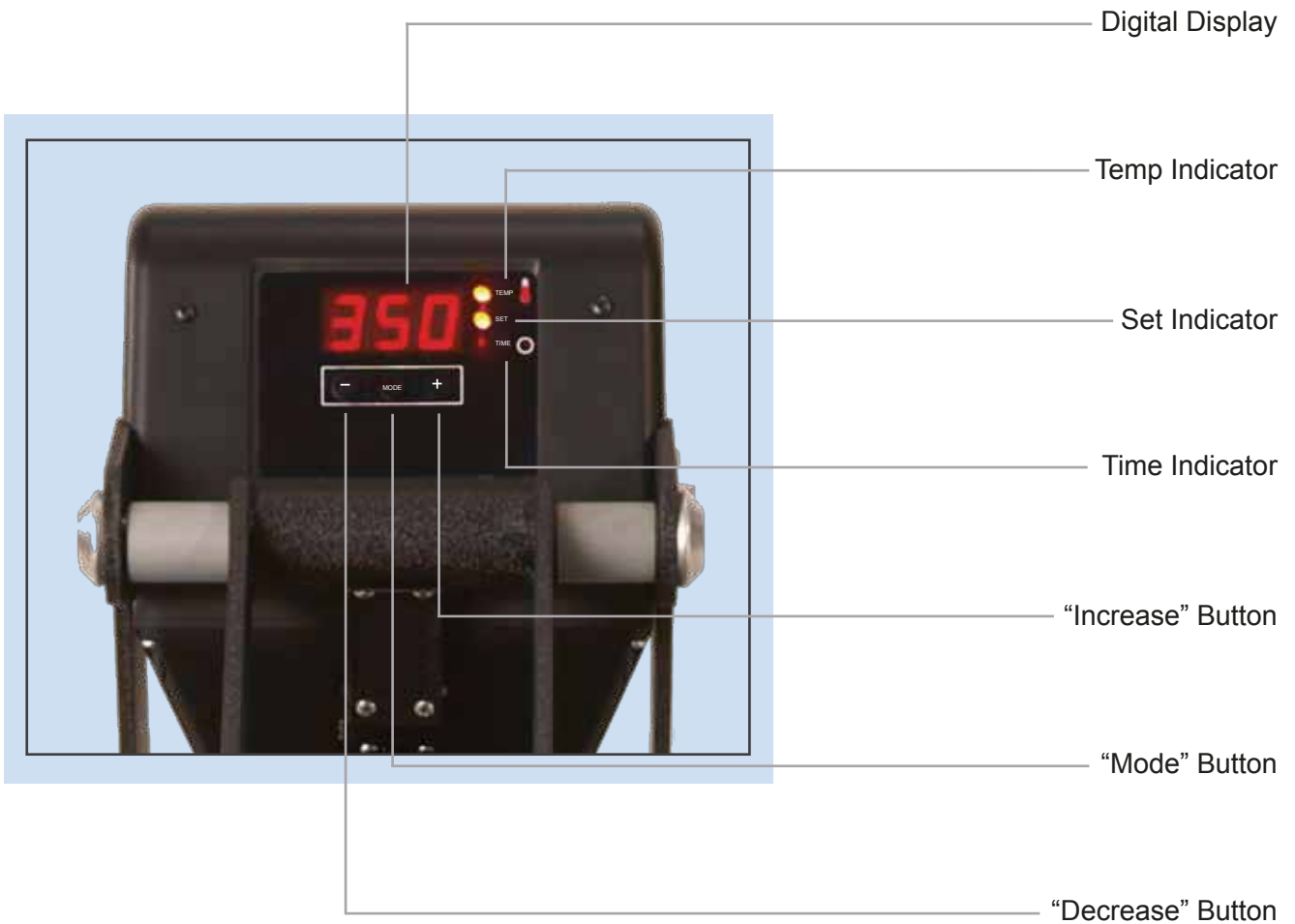

The Digital CLAM BASIC Operating Instructions are designed with you in mind. Carefully read and follow the step-by-step instructions for best results.

If you experience any difficulty, carefully re-read the instructions and try again.

Pay particular attention to the risk of burns which can be sustained by touching the heated platen during use.

Keep hands clear from the platens of the press during platen lock down as the pressure can cause injury.

Press should be placed on a sturdy suitable stand of at least 60x90cms (24"x36").

Work area must be kept clean, tidy and free of obstructions to the movements of the heat press.

Power supply cord must be disconnected before cleaning or servicing press.

## 1. Connect the Power Cord



Connect the power cord into a properly grounded (earthed) electrical outlet with a sufficient amperage rating.

Your Maxx™ Clam requires a full 7,5 amp grounded circuit for 240 volt operation.

Extension Cords, if used, should be as short as possible and not less than 12 gauge. Heavy duty cords are recommended.

Circuits that have under 15 amps or other high demand equipment or appliances (especially more than one heat seal machine) should not be used.

### NOTE:

If the supply cord is damaged, it must be replaced by the manufacturer or its service agent or a similarly qualified person in order to avoid hazard. Use HSJ type, rated 250V-10 AMP for replacement.

### CAUTION

FAILURE TO FOLLOW THESE INSTRUCTIONS WILL CAUSE:

1. Erratic controller functions.
2. Inaccurate displays and slow heat-up.
3. The circuit breaker to disengage.

## 2. Switch the system on

Locate the lift handle and position the heat platen in the up (load) position.  
Locate the Power ON/OFF Switch on the press.  
Turn the Power Switch on.



# Adjust Temperature & Time

## 3. Adjusting the Temperature

### Adjust the temperature

Locate the LED Display on the Press.

- Press the Mode Select Button located in the centre of the Control Panel. The (SET) and (TEMP) lights located next to the display will illuminate indicating you are in the adjust temperature mode.
- Next, press the (-) button located to the left of the Mode Select button to lower the temperature setting, or press the (+) button located to the right of the Mode Select button to raise the temperature setting. The temperature can be set from 205° F (96° C) to 430° F (220° C).
- The LED will display changes as you make them.

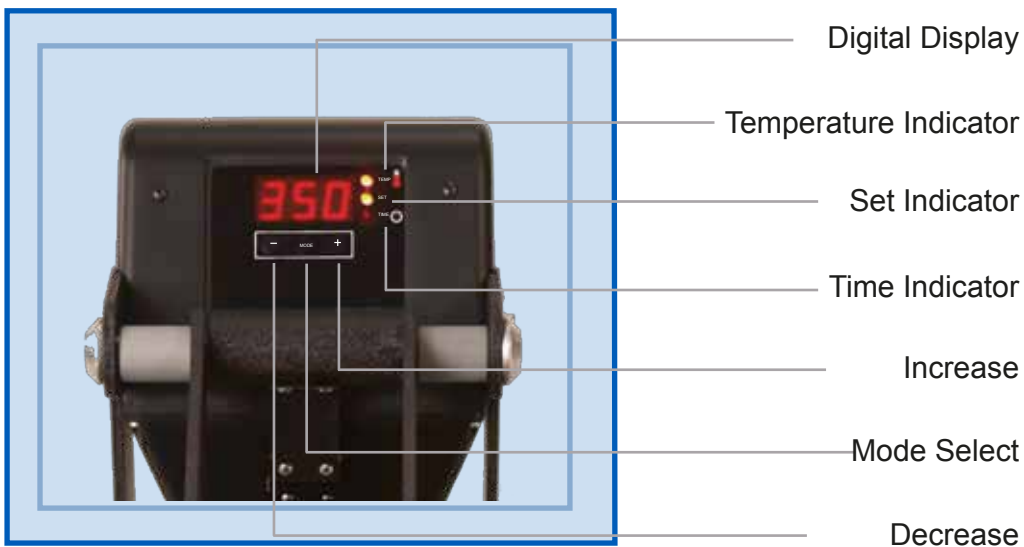

**NOTE:** The temperature indicator will only display temperatures 200°F (93°C) and up.

## 4. Adjusting the Time

### Adjust the time

- Once you have adjusted the temperature, press the Mode Select button again. This will advance you to the Time mode. The set and time lights will illuminate, indicating that you are in the Time mode.
- Adjust the time in the same manner that you adjusted the temperature. Select the desired time and push the Mode Select button again to exit the time settings. All lights will be off and the press will return to the Print Mode.



## 5. Adjusting the Pressure

The Maxx™ Press Digital Clam features a patented, Over-the-Centre Pressure Adjustment located in the centre of the heat platen.

Adjust the pressure by turning the knob clockwise to increase pressure and counter clockwise to decrease pressure.

**REMEMBER:**

To allow for the thickness of your garment when adjusting the pressure.

**WARNING:**

Structural damage caused by excessive pressure is not covered under the limited warranty!



## 6. Print

Once your equipment has reached the designated temperature, position the garment and application and proceed to press.

- Lower and lock the heat platen into the press position. This procedure will start the automatic timing process.
- The timer will automatically count down and audibly signal you to lift the heat platen into the “UP” position when the press cycle is complete.
- The time will automatically re-set and you are ready to continue with the next application.



# Maxx™ Clam Parts Location Guide

The MAXX™ Press Digital Clam is available in three sizes: 28 x 38 cm, 38 x 38 cm, 40 x 50 cm

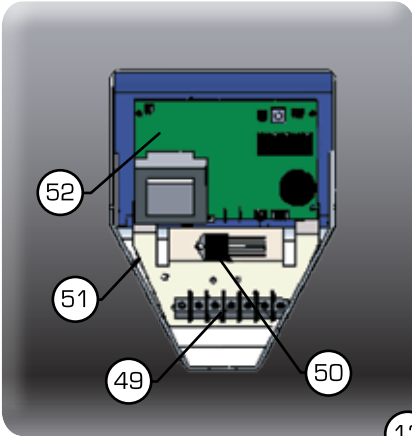

When ordering replacement parts, refer to the following color codes

For a 28 x 38 cm press - use colour code **A**

For a 38 x 38 cm press - use colour code **B**

For a 40 x 50 cm press - use colour code **C**

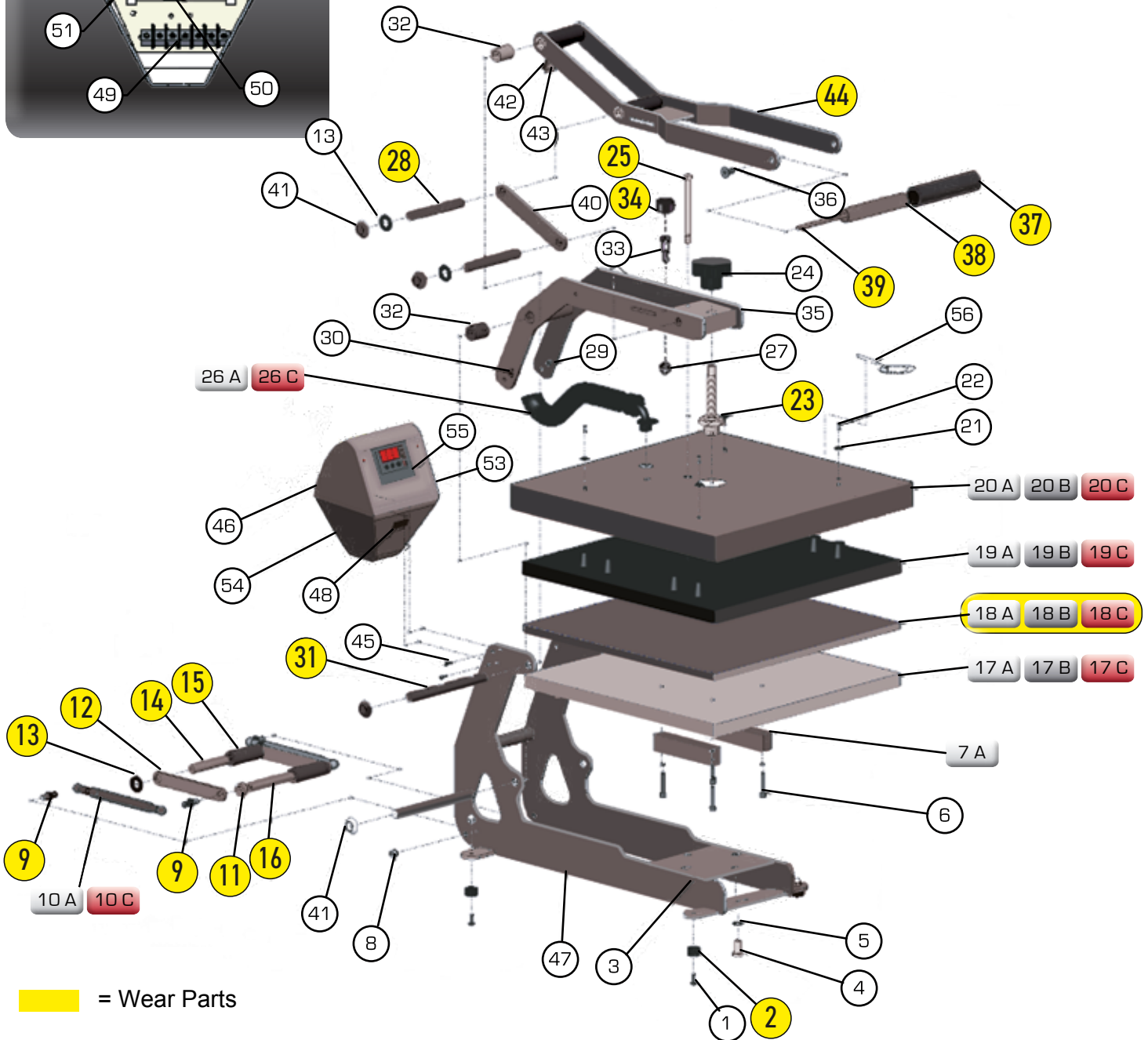

# Maxx™ Glam Replacement Parts List

Item #	Part Name	Part #	Qty.
1	Hex Soc Button HD # 10 - 32 x 1/2"	3 - 1011 - 164	4
2	Rubber Foot	1 - 1256	4
3	Acorn Hex Nut	3 - 1011 - 182	4
4 A-B	Hex Cap HD Screw - 3/8" - 16 x 3/4" 16 x 20 15 x 15	3 - 1011 - 41	2
5	Lock Spring Washer	2 - 1006 - 43	2
6	Hex Soc Screw 1/4 - 20 x 1 1/4"	3 - 1011 - 62	4
7 A-B	Lower Platen Spacer 16 x 20 15 x 15	1 - 1279	2
7 C	Lower Platen Spacer 11 x 15	0140	1
8	Nylon Hex Nut	2 - 1006 - 20	2
9	Ball Stud - 10mm	1 - 1939	4
10 A	Gas Spring 16 x 20	1 - 2086	2
10 B-C	Gas Spring 15 x 15 11 x 15	1 - 1874	2
11	Steel Spacer	1 - 2114	2
12	Bridle Links	KIT 3 - 6906	2
13	Nylon Washer	1 - 1048 - 3	6
14	Threaded Pin 1/4" - 20 x 3"	1 - 2091	1
15	PVC Spacer 1/2" I.D. x 2.48	1 - 2098	1
16	Threaded Pin 3 5/8" x .5" Dia. 1/4" - 20	1 - 2092	1
17 A	Lower Platen 16 x 20	2 - 1029	1
17 B	Lower Platen 15 x 15	3 - 1086	1
17 C	Lower Platen 11 x 15	3 - 1199 - 1	1
18 A	Silicone Pad Gray 16 x 20	1 - 1011	1
18 B	Silicone Pad Gray 15 x 15	1 - 1473	1
18 C	Silicone Pad Gray 11 x 15	1 - 1875	1
19 A	Heat Platen 16 x 20	2 - 1002 - 3	1
19 B	Heat Platen 15 x 15	3 - 1320	1
19 C	Heat Platen 11 x 15	3 - 1199	1
20 A	Heat Platen Cover 16 x 20	3 - 1332	1
20 B	Heat Platen Cover 15 x 15	3 - 1337	1
20 C	Heat Platen Cover 11 x 15	3 - 1331	1
21	Finish Washer	1 - 1063	4
22	Cover Screw 10 - 24 x 1/2"	3 - 1011 - 217	4
23	Adjustment Spindle	2 - 1081	1
24	Pressure Adj. Knob	1 - 1012	1
25	Safety Bolt " - 18 x 4 1/2"	3 - 1011 - 238	1
26 A-B	Elbow 90 degree with tubing 16 x 20 15 x 15	1 - 1940	1
26 C	Topaz Connector with flex tubing 11 x 15	1 - 1353	1
27	Shoulder Bolt	3 - 1011 - 55	1
28	Steel Pin 1/2" Dia. x 4.38	1 - 2093	2
29	Soc HD Cap Screw 1/4" - 20 x 3/8"	3 - 1011 - 215	2
30	Hex HD Nut - 1/4" - 20	2 - 1006 - 12	2
31	Steel Pin - 1/2" Dia. x 6.45	1 - 2094	2
32	PVC Spacer - 1/2" I.D. x 1.1	1 - 2097	4
33	Nylon Nut	2 - 1006 - 20	1
34	Rubber Foot	1 - 1256	1
35 A-B-C	Adjustment Arm Assembly 16 x 20 15 x 15 11 x 15	KIT 3 - 6903	1
36	JCN Nut	2 - 1006 - 2	2
37	Foam Grip	1 - 1540	1
38	PVC Spacer 1/2" I.D. x 5"	1 - 2096	1
39	All Thread Pin - 1/4" - 20 x 4 3/4"	1 - 1042 - 1	1
40	Lift Links	KIT 3 - 6905	2
41	Hucap 1/2"	1 - 1107 - 1	8
42	Magnet	1 - 1219	1
43	Magnet Bracket	1 - 2085	1
44 A-B-C	Handle Assembly 16 x 20 15 x 15 11 x 15	KIT 3 - 6904	1
45	Phillips Pan HD Screw - #6-32 x 1/2"	3 - 1011 - 152	4
46	Housing	4 - 1172	1
47 A-B-C	Base Assembly 16 x 20 15 x 15 11 x 15	KIT 3 - 6901	1
48	Proximity Switch	1 - 1211	1
49	Terminal Block	1 - 1290	1
50	Triac	1 - 1059	1
51	Controller Bracket	2 - 1661	1
52	SSTT Control Board	1 - 2017	1
53	On/Off Switch	1 - 2087	1
54	Circuit Breaker	1 - 1331	1
55	Display Overlay	1 - 2018	1
56	Probe	1 - 1272 - 1	1

 = Wear Parts

# Maxx™ Glam Electrical Schematic

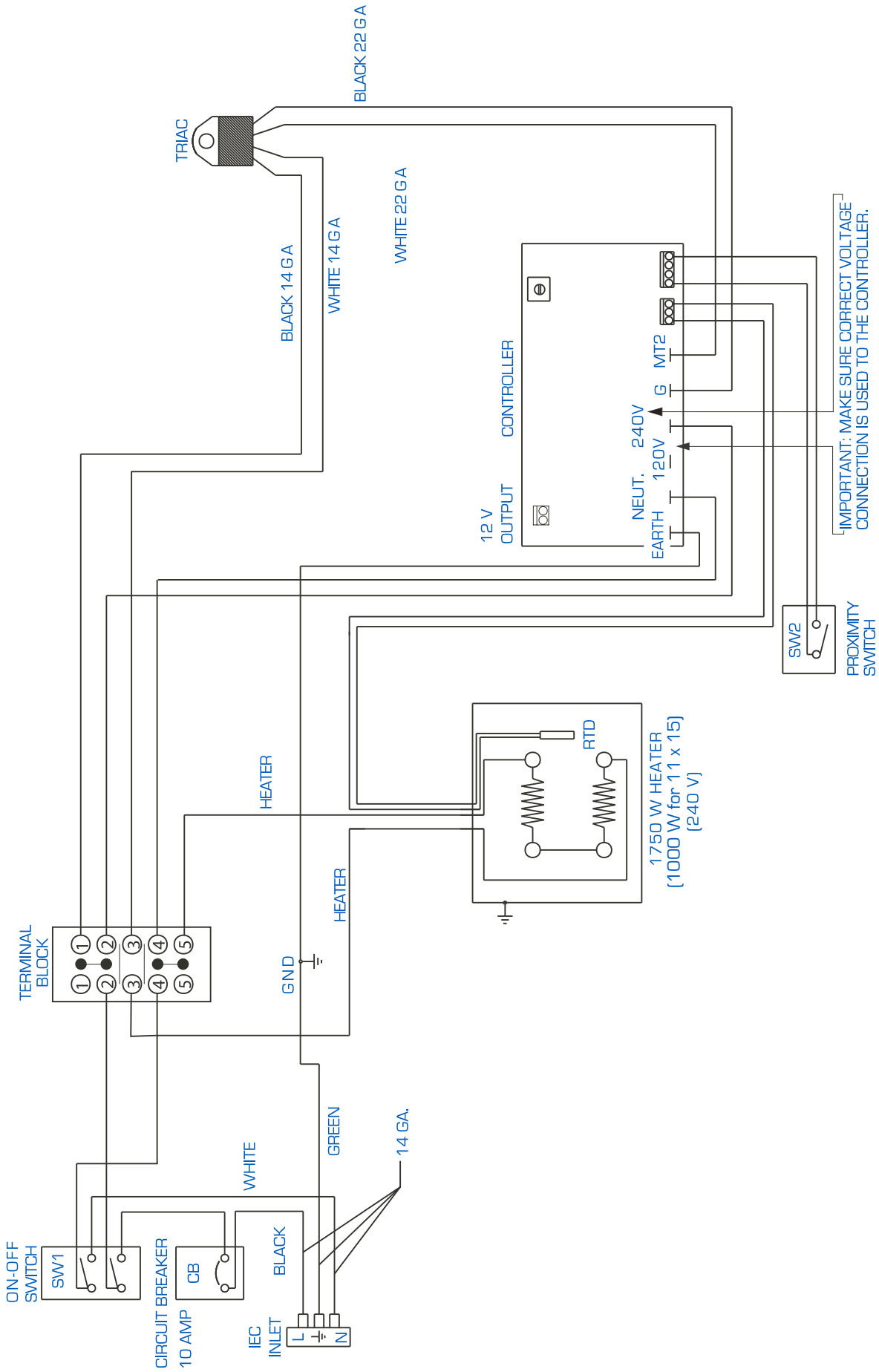

**EC conformance explanation:**

For the purposes of the EC-Machine Guideline 98/37EU, Appendix 2A and the EC Low Voltage directive to 73/23 European Economic Community as well as the EC EMV-guideline 89/336. For the manufacturer STAHL'S Hotronix Division, we state as European Commissioners, that our product:

A Transfer Press for ironing of thermo application.

Model: Maxx™ Clam Series

The product supplied corresponds to the following appropriate regulations:

EMC Directive (2014/30/EU), Machinery Directive (2006/42/EC), RoHS Directive (2011/65/EU) & Low voltage Directive (2006/95/EC)

Applied Harmonized norms

EN 55011:2007	EN 61000-4-4:2004	EN 61000-3-2:2006
EN 61000-6-1:2007	EN 61000-4-5:2006	EN 61000-3-3:1995
EN 61000-4-2:1995	EN 61000-4-6:1996	EEC 60335-2-44
EN 61000-4-3:2006	EN 61000-4-11:2004	
EN 61000-4-8:1993	IEC 61000-3-3:1994	



It is possible that not all the listed norms apply to the above mentioned product.

STAHL'S Europe GmbH

(Frank Brücker, Chief Executive STAHL'S Europe GmbH)

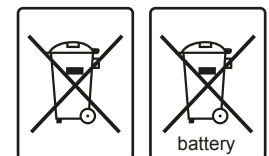

**WEE and RoHS Symbols**

STAHL'S Europe GmbH will take back ALL heat press machines FREE OF CHARGE (inside the EU) that have been manufactured by them, even those sold prior to the date stated above, subject to the heat press machine being delivered to them at the owners costs.

STAHL'S Europe GmbH will break down the heat press machine and ensure that all recyclable parts are correctly recycled, and non-recyclable parts will be disposed of in accordance with legal requirements. In an effort to make such transaction as smooth to customers as is possible, and to ensure that all STAHL'S heat presses are identifiable, all heat press machines supplied by STAHL'S Europe GmbH will have the logo/brand of STAHL'S Hotronix clearly marked upon them.

Contact:

STAHL'S Europe GmbH, Dieselstraße 62, 66763 Dillingen, Germany

Telefon: +49 (0) 68 31/97 33-0, Fax: +49 (0) 68 31/97 33 45, www.stahls.de, info@stahls.de

## **Warranty Policy**

STAHL'S Europe GmbH provides the following warranty for the Maxx™ Clam, subject to the following terms:

### **Duration**

The warranty period of 2 years commences from the date of receipt by the buyer of the heat press machine, which can be verified by the invoice or similar documents. The warranty does not cover any damage caused by normal wear and tear.

### **Repair**

If any parts are found to be defective, despite proper use, authorised use and not as a result of fair wear and tear, within the warranty period, then they will be replaced or repaired without question provided that STAHL'S Europe GmbH have been informed of any such claim in writing within one week of the occurrence of the failure. The terms and conditions of the commercial transaction are specifically excluded from this warranty, especially §§377 et.seq. HGB. Following any claim under the warranty, the warranty period will not be extended for either the heat press machine or for any replaced parts. Any exchanged parts will be the property of STAHL'S Europe GmbH. No charge will be made for any labour or components for any claim under the warranty. STAHL'S Europe GmbH operates a "bring in" guarantee for the first six months from the date of the purchase, under which all delivery and return costs will be borne by STAHL'S Europe GmbH. After the first six months from the date of purchase, all delivery and return costs will be borne by the customer.

### **Rectification**

Initially the customer's rights are limited to repair by STAHL'S Europe GmbH. Should the repair or remedial works finally fail, it will become the customer's right according to §462 BGB to receive a payment reduction, or to withdraw from the contract. In every case, any further claim would be excluded, especially indemnity claims (including consequential damages) and those resulting from defects, unless it can be proven that STAHL'S Europe GmbH acted intentionally, grossly negligently, or there are requirements according to §463 BGB.

### **Returns**

Goods may only be returned with express written authorisation from STAHL'S Europe GmbH. Customers must ensure that the heat transfer machine is properly fixed to the supplied wooden panel, and returned in the original carton, which must include the contact details of the sender, together with details of any failure which requires remedying. STAHL'S Europe GmbH will not be liable for any damages howsoever caused during transportation as a result of improper packaging.

### **Acceptance of Returned machines manufactured by STAHL'S for disposal**

STAHL'S Europe GmbH agrees to accept the return of all heat press machines manufactured by STAHL'S or with their genuine trademark for Free of Charge disposal, subject to the costs of delivery to STAHL'S Europe GmbH being borne by the sender. WEEE DE 54539730.

### **Packaging**

The original carton (box), packaging and wooden transport panel must be retained for any future transportation of the heat press machine.

### **Circuit Breaker**

If the circuit breaker should become dislodged, it can easily be reinstated after the heat press machine has cooled down. It is recommended to try and eliminate the source of any failure by using the error checklist.

### **Set Up**

It is important that the heat press machine is fixed securely to your worktop. To set up the press, it is necessary to fully open the press, and place the substrate that is to be printed flat on the lower platen. If the press is not fully open, there is a risk of being burnt. Always follow the supplied instructions for printing for every respective material.