

DUAL AIR FUSION IQ[®]

OPERATOR'S MANUAL



STAHL'S
Hotronix[®]

When using your heat press, basic precautions should always be followed, including the following:

1. Read all instructions.
2. Use heat press only for its intended use.
3. To reduce the risk of electric shock, do not immerse the heat press in water or other liquids.
4. Never pull cord to disconnect from outlet, instead grasp plug and pull to disconnect.
5. Do not allow cord to touch hot surfaces, allow heat press to cool completely before storing.
6. Do not operate heat press with a damaged cord or if the equipment has been dropped or damaged. To reduce the risk of electric shock, do not disassemble or attempt to repair the heat press. Take it to a qualified service person for examination and repair. Incorrect assembly or repair could increase the risk of fire, electric shock, or injury to persons when the equipment is used. Power supply cord must be disconnected before cleaning or servicing press.
7. This appliance is not intended for use by persons (including children) with reduced physical, sensory or mental capabilities, or lack of experience and knowledge, unless they have been given supervision or instruction concerning use of the appliance by a person responsible for their safety.
8. Close supervision is necessary for any heat press being used by or near children. Do not leave equipment unattended while connected.
9. To avoid burns, do not touch hot metal parts or the heated platen during use.
10. To reduce the likelihood of circuit overload, do not operate other high voltage equipment on the same circuit.
11. If an extension cord is necessary, then a 20-ampere rated cord should be used. Cords rated for less amperage may overheat. Care should be taken to arrange the cord so that it cannot be pulled or tripped over.
12. Keep hands clear of the upper heat press platen during lock down as the pressure may cause injury.
13. Heat press should be placed on a sturdy, suitable stand at least 91,5 cm L x 60 cm W x 75 cm height.
14. Work area must be kept clean, tidy, and free of obstructions.

Important

The Hotronix® Dual Air Fusion IQ® is equipped with a Quick Release Button located on top of the control housing. When pressed, this button activates a quick release of the heat platen when in the print position and automatically returns the platen to the UP position. Once activated, the button can be reset by pushing it in. The press will return to Normal Operating Mode.

Light on = Normal Operating Mode

Light off = Quick Release Mode

In the event of a loss in air pressure while the heat platen is in the down or print mode, disconnect the power supply (or flip power switch to the OFF position) and remove opposite lower platen. Then push the top of the Dual Air Fusion IQ® to the open position.

After air pressure has been restored, turn the heat press back on and press the yellow Shop Air Pressure icon on your screen. You may then replace the lower platen and resume printing.

Table Of Contents

Safety Instructions	2
Machine View	4
Operating Instructions	5-7
Connecting the System	5
Start Up/Shut Down	5
Home Screen	6
Prepare to Print	7
Touch Screen Guide	8-13
Setup Menu	8
Password Setup (Manager Level Only)	8
Preset Setup	9
Date & Time Setup	10
Display Setup	10
Auto On & Off Setup	10
System Setup (Manager Level Only)	11
Calibration (Manager Level Only)	12
Updating Software	12
Laser Alignment Setup	13
Connecting to the IQ[®] Portal	14
Electrical Schematic	15
Replacement Parts List & Parts Location Guide	16-19
Contact	20

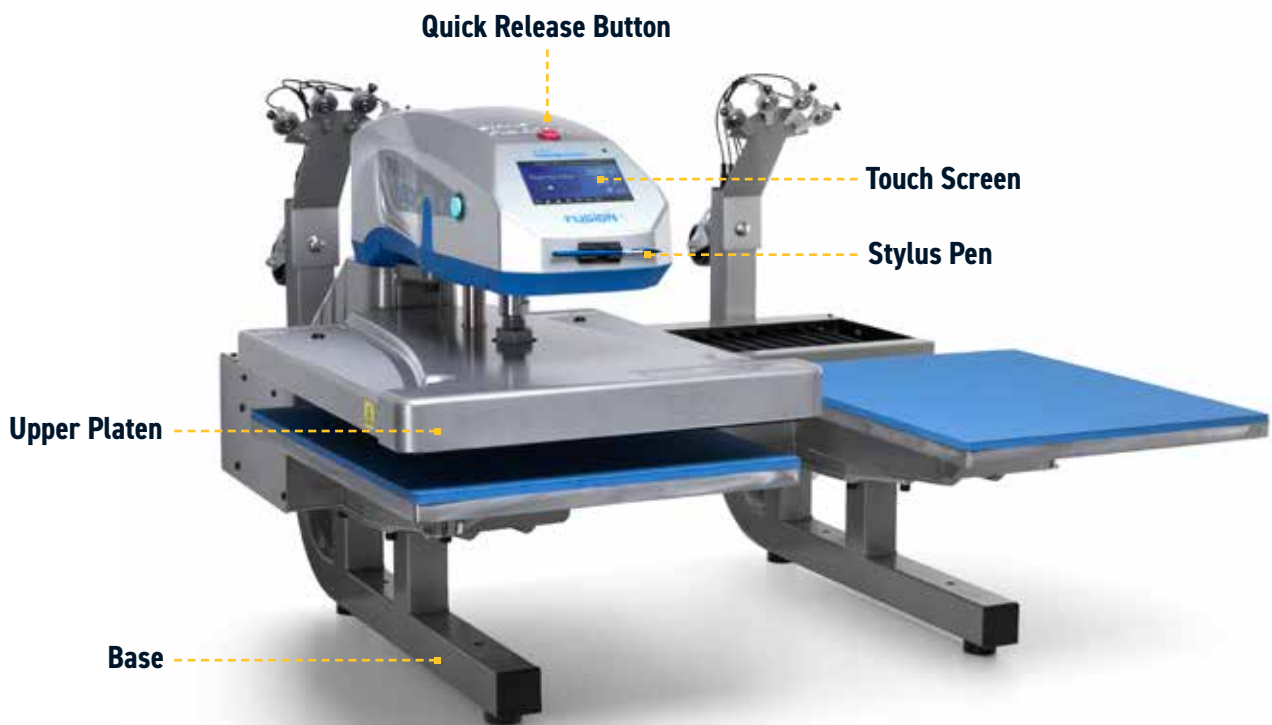

Operating Instructions

Connecting the System

Insert power cord into IEC inlet located on the side of press (1.1).

Connect the power cord into a properly grounded electrical outlet with a sufficient amperage rating.

Voltage

240 volt requires a full 10-amp grounded circuit

Extension Cords

If used, extension cords should be as short as possible and not less than 12 gauge. Heavy duty cords are recommended.

Circuits

Circuits that have less than 15 amps, or have other high demand equipment or appliances (especially more than one heat press) plugged in, should not be used.

Note: If supply cord is damaged, it must be replaced by the manufacturer, its service agent, or a similarly qualified person to avoid hazard. Use SJT type rated 300 V cord for replacement.



1.1



1.2



2.1

Start Up/Shut Down

To start up your heat press:

Flip the power switch ON (2.1). A splash screen displaying the Hotronix® logo and current software version is shown for several seconds.

To turn your heat press off, flip the power switch OFF.

To place your heat press into Standby Mode, touch and release the Power icon on the Home Screen (3.2). In Standby Mode, the heater turns off while the Touch Screen remains on, displaying an orange background as a warning if the platen is still hot (above 100°F / 38°C).

NOTE: Standby Mode must be used for the Auto On feature to function (10.1). The Auto On feature will not work if the power switch (2.1) is in the OFF position.

To start up your heat press while in Standby Mode, touch and release the Home icon on the Standby Screen.



Home Screen

Displays the selected preset. Touch and hold to see application settings.

NOTE: Holding down material name will display targeted application settings. Screen displays current temperature, pressure, and time.

Displays multiple heat application preset step. Touch the empty circled numbers to switch between preset steps.

Touch and edit your favorite presets.

Lock the screen (Manager-level only) to prevent User-level operators from changing settings.

Touch and edit Users to control operator access level and track press usage by operator in the IQ® Portal.

Touch Setup Menu.

Touch to toggle tack mode.

Touch to cycle through Shuttle modes.

Place press in Standby Mode to take advantage of the scheduled Auto On feature.

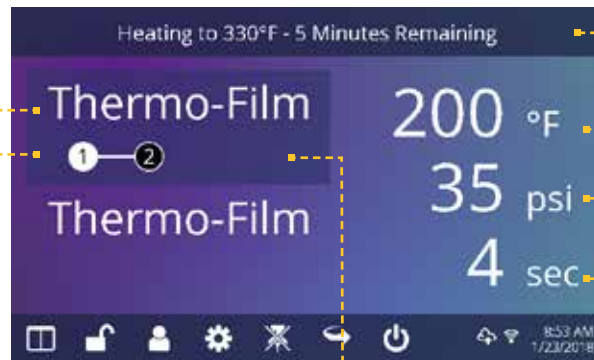

3.1

Status bar provides helpful information regarding heat press.

Displays the current application temperature and time. To view pressure, touch 0 and target pressure is displayed. Manual pressure adjustment required.

Highlighted preset represents the active platen; top is A, bottom is B.

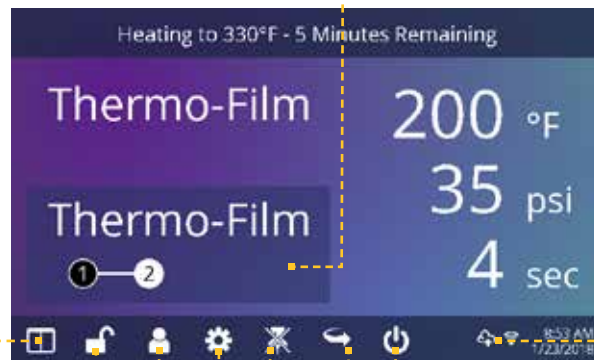

3.2

IQ® Portal and WIFI connection status.

Operating Instructions

Prepare to Print

Entering Application Settings

Before you begin heat applying, verify the appropriate application settings are entered for both lower platens. Application settings for lower platen A and platen B are stored separately.

To enter application settings for lower platen A, the upper platen must be in the A position. If it is in the B position, depress the foot pedal (4.2) while the Auto Shuttle function is enabled (3.2) to shuttle to A position.

Select a preset material application (7.1) for the A position or manually enter temperature, pressure and time based on transfer material instructions.

Shuttle the upper platen to the B position using the foot pedal (4.2).

Select a preset material application (7.1) for the B position or manually enter temperature, pressure and time based on transfer material instructions. For best results, temperature settings for A and B positions should match.

Basic Printing

Position the garment and design.

Shuttle the upper platen over the garment and design using the foot pedal.

Press both Print Buttons located on the side of the press.

The upper platen will lower into PRESS position. The timer will automatically begin to count down.

When the Print Cycle is complete, the top platen will return to the UP position.

CAUTION: When Auto Shuttle mode is enabled (Arrow icon), the upper platen will automatically shuttle to the opposite platen.

If a second application is desired, repeat previous steps.

Shuttle and Tack Modes

Touch the Shuttle icon (3.2) to cycle through three shuttle modes:

- Auto: shuttle automatically after each Print Cycle or when the foot pedal is pressed
- Foot pedal: shuttle only when the foot pedal is pressed
- Off: air-operated shuttling is disabled and the controller housing must be shuttled by hand.

The Print Cycle will not begin unless the upper platen is in either the A or B position.

NOTE: Auto Shuttle can be disabled for individual preset stages (7.6) for a heated post-cure effect.

Touch the Tack Mode icon (3.2) to toggle ON/OFF. Tack mode is useful for experimenting, fine-tuning print recipes or very brief application times.

- Tack Mode On: press and hold both Print Buttons to start Print Cycle. Print Cycle completes when buttons are released
- Tack Mode OFF: press and hold both Print Buttons to start Print Cycle. Print Cycle completes when countdown timer reaches 0.

Pressing the print buttons a second time during the print cycle will interrupt it.



4.1



4.2

Setup Menu

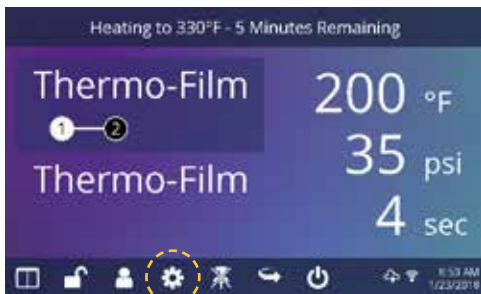

5.1

Touch the Settings icon on the Home Screen (5.1) to configure your heat press.

Managers can access all setup options, while Users can access a limited set (5.2).

- Managers default password: M



5.2

Password Setup (Manager Level Only)

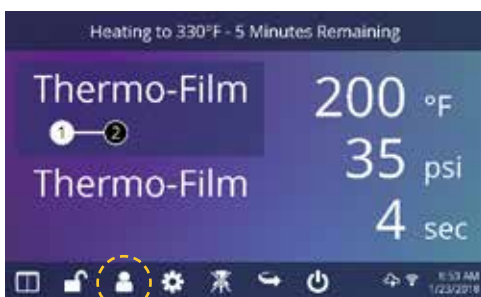

6.1

Touch the User icon on the Home Screen (6.1) or Setup Menu (6.2) to select, add, and edit Users.

Touch and edit Managers and Users to configure access to settings (6.3, 6.4). Heat press reports on the IQ® Portal can be filtered by User to track individual operator performance.

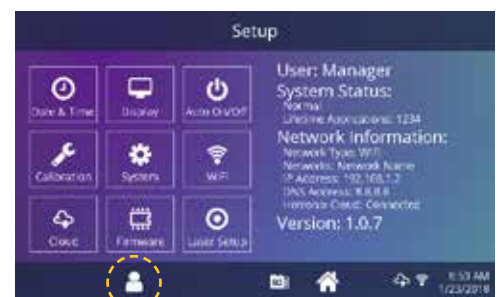

6.2



6.3

Touch the arrow keys on the taskbar to scroll through a long list of Users (6.5).



6.4

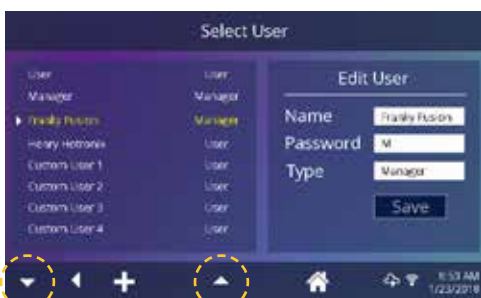

6.5

Touch Screen Guide

Preset Setup



7.1

Touch the Columns icon (7.1) to select from a list of saved presets (7.2).



7.2

Touch the arrow keys on the taskbar to scroll through a long list of presets (7.3).

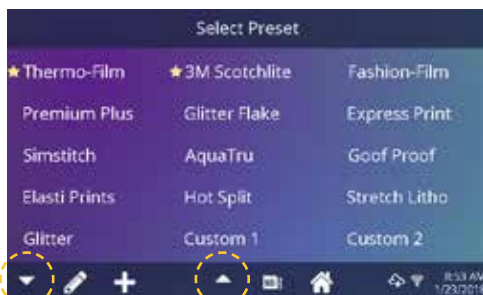

7.3

Touch a preset to select a material. The preset selection is applied to the active platen.



7.4

Touch the Pencil icon (7.4) to enter edit mode, then touch preset name to edit settings. Touch Enter to save changes.

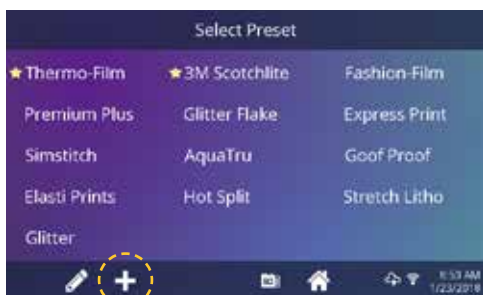

7.5

Touch the Plus icon to create a new preset (7.5).



7.6

Name your preset and enter desired temperature, time, and pressure. When creating a new preset, the current Home Screen application settings are selected automatically (7.6).



7.7

Touch the empty circled numbers to set multiple preset stages for pretreatment or multi-step applications (7.7).

Auto Shuttle can be disabled on individual preset stages for a heated post-cure useful in some applications, including Direct-To-Garment printing. This setting will override Shuttle settings on the Home Screen (3.2).

Date & Time Setup

Touch the Settings icon on the Home Screen.

- Touch Date & Time, information displays on right of screen (8.1).
- Touch up/down arrows to select time zone.
- Touch Auto to automatically synchronize the heat press clock. The heat press must be connected to a WIFI network with access to the Internet.
- Touch Daylight Saving to enable daylight saving mode.



8.1

Display Setup

Touch the Settings icon on the Home Screen.

- Touch Display, information displays on right of screen (9.1).
- Touch Temperature to switch between F° or C°, then touch Check Mark icon on taskbar to save.



9.1

Auto On & Off Setup

Touch the Settings icon on the Home Screen.

- Touch Auto On/Off, information displays on right of screen (10.1).
- Touch Enable, then On Hour/Minute and Off Hour/Minute, selecting Enter between each setting. Once entered, touch Check Mark icon on taskbar to save.

NOTE: Standby Mode must be used for the Auto On feature to function (3.2).
The Auto On feature will not work if the power switch (2.1) is in the OFF position.



10.1

Touch Screen Guide

System Setup (Manager Level Only)

Touch the Settings icon on the Home Screen.

- Select System, information displays on right of screen (11.1).
- Touch Power Save and select time, then touch Check Mark icon on taskbar to save.
- When enabled, your heat press will enter Standby Mode if it is not used for the specified number of hours.



11.1



Calibration (Manager Level Only)

Your heat press comes pre-calibrated from the factory. Calibration is only required after sensor or controller replacement. Incorrect calibration can result in poor print results or damage to your heat press which is not covered by warranty.

All Fusion IQ® heat presses have a temperature calibration function (12.1).

- Turn on heat press and heat to 350°F/177°C.
- Place temperature strip on center of platen and press for 5 seconds, or measure center of heater with contact thermocouple (not infrared) thermometer.
- Touch the Settings icon on the Home Screen.
- Touch Calibration, information displays on right of screen.
- Touch Temperature and adjust Temperature Calibration to match Target Temperature.

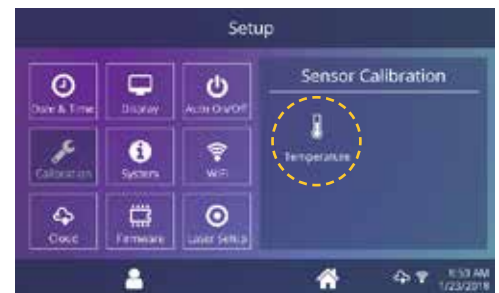

12.1

Updating Software

Touch the Settings icon on the Home Screen.

- When a software update is available, an exclamation point appears after the version number in the Setup Menu.
- Touch Firmware, information displays on right of screen. An available online update displays a cloud icon (13.1).
- Touch Update File on right of screen, then touch Check Mark icon on taskbar to start download. A downloaded update displays a memory card icon.
- Touch Downloaded Update File on right of screen, then touch Check Mark icon on taskbar to start installation.



13.1

NOTE: If a power failure occurs during installation, the heat press will attempt to install the previous software version.

Touch Screen Guide

Laser Alignment Setup

Touch the Settings icon on the Home Screen.

- Touch Laser Setup, information displays on right of screen (14.1).
- Touch empty circled numbers 1-4 to toggle lasers ON or OFF on A and B platens



14.1



Create Your Account

- Using a phone or computer, visit iq.hotronix.com to create an account (15.1).
- Enter your name, email, and password.
- Click on the confirmation link in the email you receive.
- Your account has been created.



15.1

Register a Heat Press

- Click on Manage Heat Presses, then New Heat Press.
- Select heat press type, enter serial number, and enter a name for the heat press (optional).
- Click on Create Heat Press and enter the verification code given.
- On the heat press Setup Menu, touch WIFI and connect to your WIFI router or mobile hotspot (15.2).
- On the heat press Setup Menu, touch the Cloud icon and enter the verification code displayed in the IQ® Portal (15.3).
- Your heat press has been registered.



15.2

Create & Assign Users

- Click on Manage Operators, then New User.
- Enter a name and select a privilege level. Managers can access all heat press settings while Users have limited access.
- Click on New User, then Assign Machines in the sidebar.
- Select a machine and click Assign.
- On the heat press Setup Menu, touch the Cloud icon, then Manual Sync (15.4).
- Reporting will show impressions made by the Users.



15.3



15.4



Electrical Schematic

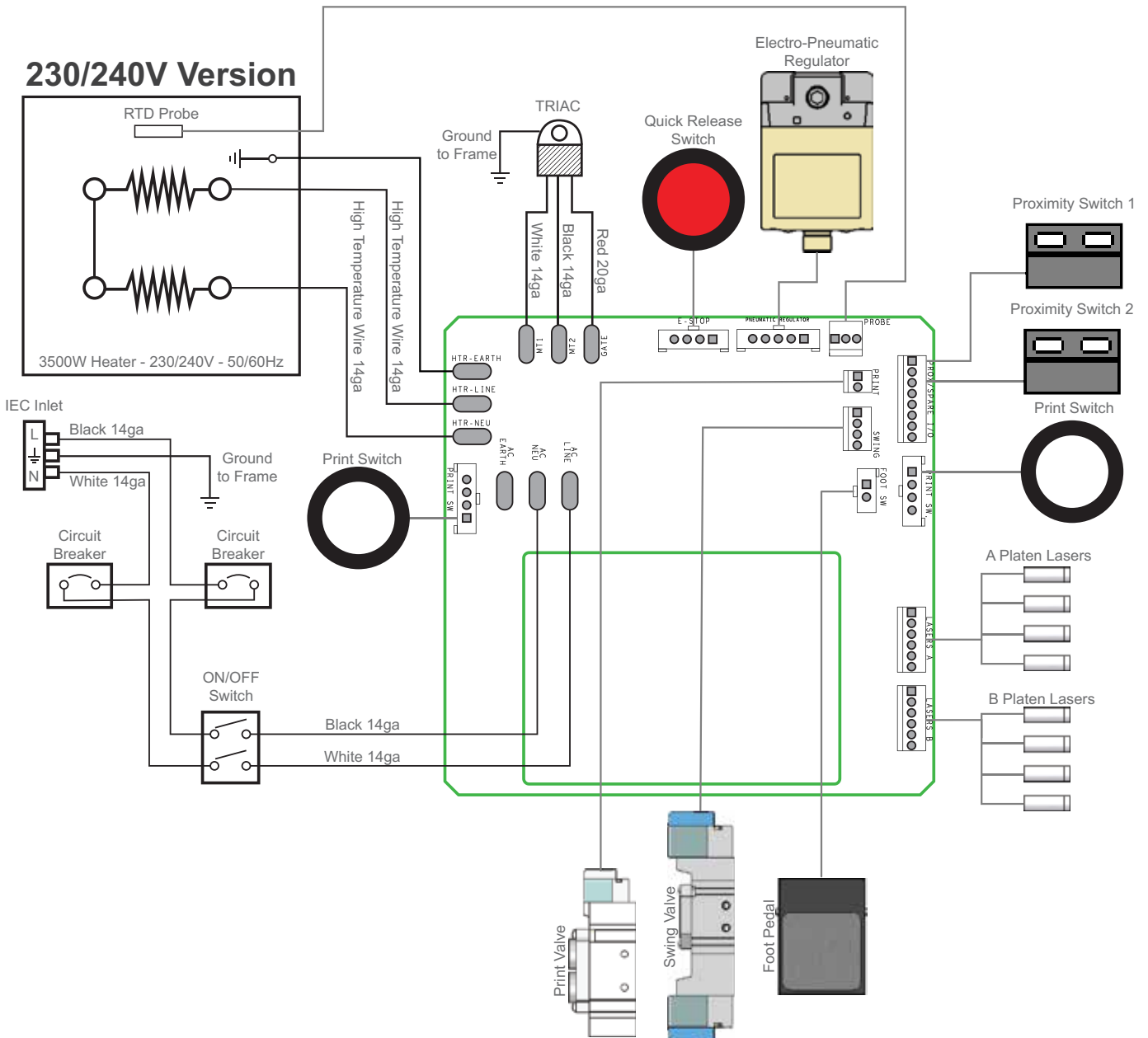

HOTRONIX® DUAL AIR FUSION IQ®

Replacement Parts List

ITEM #	PART NAMEP	ART #Q	TY
1A	ir Fusion Control Housing	1-2197	1
2	Button, White, Print Switch	1-2319	2
3	Button, Red, Quick Release	1-2270	1
4	Fusion IQ Power Board	—	1
5	Fusion IQ Power Bracket	1-2473	1
6	Screw, Sheet Metal #6 x 1/2"	3-1011-235	6
7	Fusion IQ Latch	1-2474	2
8	Spring, 1/4" x 1", 1.7lbs/in	—	2
9	Fusion IQ Controller	1-2463	1
10	Fusion Overlay NextGen	1-2198-1	1
11	Cap, Plastic Black 1/2"	1-1971	2
12	Touchscreen Stylus Holder	1-2386	1
13	Touchscreen Stylus	1-2385	1
14	Power Switch Cover Plate	1-2422	1
15	Screw, Machine #6-32 x 1/2"	3-1011-19	7
16	Nut, #6-32 Hex with Lockwasher	2-1006-50	6
17	Chevron Cover Plate	1-2423	1
18	Screw, Machine #8-32 x 3/4"	3-1011-155	4
19	Air Fusion Upper Casting	3-1341	1
20	Bushing, Flange Tin	1-2282	1
21	Dual Fusion Bearing Spacer, 3/16"	1-2396	6
22	Dual Fusion Bearing Spacer, 1/4"	1-2397	2
23	Spanner Nut 2in-18	2-1006-95	1
24	TRIAC	1-1059	1
25	Air Cylinder 6in	1-2264	1
26	Washer, Tin Nord-Lock	2-1006-94	1
27	Nut, Hex 1"-12	2-1006-96	1
28	Dual Fusion Heater Spacer	—	1
29	Screw, Button Socket Head 5/16"-18 x 1-1/8"	—	6
30	Air Fitting, Elbow 1/4" NPT x 1/4" Tube	4-1015-12	5
31	Screw, Machine #10-24 x 1/2"	3-1011-217	4
32	Washer, Plastic Finishing	1-1063	4
33	Air Fusion Heater Cover	1-2263	1
34	Insulation 16 x 20	1-1020	1
35	C-Clip	1-2286	1
36	Guide Tube, XRF & XRF2	1-2290	1
38	Screw, Socket Head 3/8"-16 x 1"	3-1011-43	1
39	Screw, Socket Head 5/16"-18 x 3/4"	3-1011-100	1
40	Screw, SS Phillips #8-32 X 1/4"	3-1011-87	1
42	Thermostat Disc	1-2076	1
43	Screw, SS Sheet Metal #4 X 1/4"	3-1011-98	2
44	Temperature Probe	1-1272-1	1
45	Heat Platen 16 x 20 3500W Milled (No Ears)	2-1002-3-HW	1
46	Screw, Socket Head Cap Low Profile 1/4-20 X 3/4"	3-1011-245	4
47	Pneumatic Package, Dual Air Fusion	1-2269-1	1

ITEM #	PART NAMEP	ART #Q	TY
50	Screw, Sheet Metal Hex #8 x 1/2"	1-2421	4
51	Screw, M4x0.7 x 8 Pan Phillips	1-2417	5
52	Print Valve	1-2299	1
53	Air Fitting, Straight Hex 1/4" NPT 1/4" Tube	1-2427	3
54	Air Fitting, Mufflex, 1/8" NPT	1-2418	2
55	Speed Control Muffler	1-2339	1
56	Air Fitting, Check Valve, 1/4" Push-to-Connect	1-2419	1
57	Screw, Pan Phillips M3x05 x 6mm	—	2
58	Swing Valve	1-2298	1
59	Air Fitting, Elbow Restrictor #10-32 UNC 5/32" Tube	1-2428	2
60	Air Fitting, Elbow #10-32 UNF 5/32" Tube	1-2350	4
61	Electro-Pneumatic Regulator	1-2293	1
62	Air Fitting, Tee, 1/4" Push-to-Connect	1-2420	1
63	Pneumatic Regulator, Mini	1-2297	1
64	Air Fitting, Elbow #10-32 UNF 1/4" Tube	1-2430	1
65	Grommet, 5/16" ID 1/2" OD	1-2429	1
75	Dual Fusion Alignment Arm	1-2394	1
76	Press Mount Casting	1-2347	1
77	Dual Air Fusion Main Spindle	2-1670-1	1
79	Press Mount Cover	1-2393	1
80	Alignment Arm Spacer	1-2398	1
81	Press Mount Keeper Bar	1-2395	1
82	Washer, 5/16" Flat SAE Zinc	2-1006-63	10
83	Screw, Socket Head 1/4"-20 x 3/4"	3-1011-243	9
84	Screw, 5/16"-18 x 1-1/8" Socket Head Cap	—	10
85	Screw, 5/16"-18 x 5/8" Flat Socket Head Cap	—	6
86	Screw, 3/8"-16 x 1-1/4" Socket Head Cap	3-1011-213IN1	1
87	Screw, Machine #8-32 x 1/4"	3-1011-10	18
88	Platen, 16x20	2-1029	2
89	Silicone P	1-2136	2
90	Adapter Plate	3-1336	2
91	Quick Release Pin	1-2215	2
92	Washer, Flat 1/4" SAE	2-1006-25	14
93	Washer, Split Lock 1/4"	2-1006-44	14
94	Screw, Socket Head Cap 1/4"-20 x 1"	3-1011-191	8
95	Dual Laser Alignment Bracket	1-2348	2
102	Laser Diode	1-2348-1	8
105	Laser Assembly Dual	1-2345	2
111	Caster, Threaded Stem	—	4
112	Rubber Foot	Kit 1-2345	4
113	End Cap, Dual Fusion Leg	Kit 1-2345	2
115	Plastic Square End Cap, 2in	1-2349	2
116	Washer Split Lock 3/8"	2-1006-43	18
117	Screw, Socket Head Cap 3/8"-16 x 1"	3-1011-43	18
118	Screw, Set #8-32 x 3/8"	—	8

* Verschleißteile/Wear Parts

Parts Location Guide

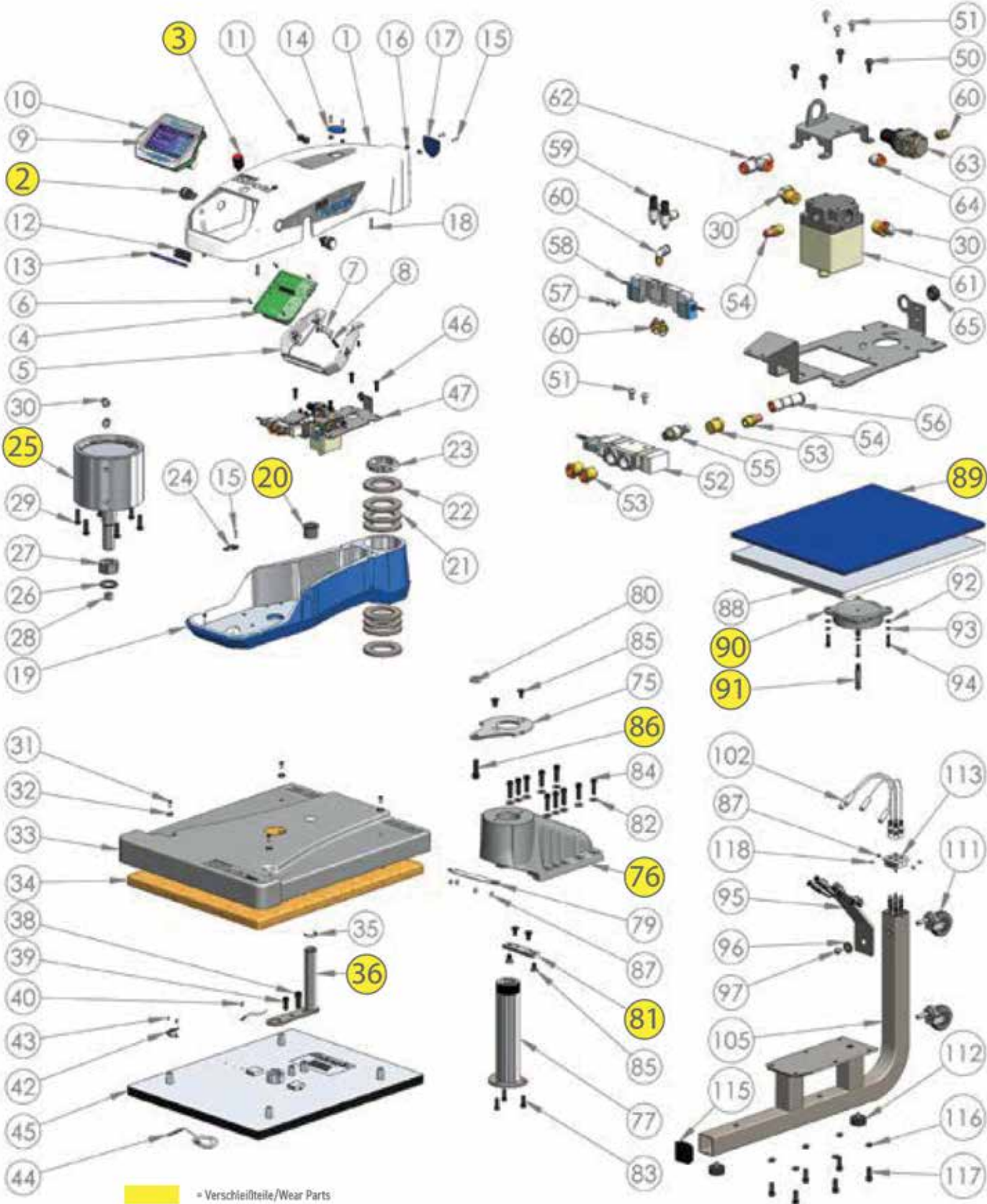

ITEM #	PART NAMEP	ART #Q	TY
121	Dual Fusion Regulator Mount	—	1
122	Air Filter & Regulator	1-1215	1
123	Curtain Bellows	1-233	2
125	Carriage Plate K	1-2342	2
126	Back Cover (Part of Tin Assembly)	Kit 1-2340	1
127	Front Cover (Part of Tin Assembly)	Kit 1-2340	1
128	End Stop PlateN	/A	2
129	Proximity Magnet	1-1219	2
130	Dual Fusion Base Casting	4-1176	1
131R	Rail and Block Rear XRF2	1-2336-1	1
132R	Rail and Block Front, XRF2	1-2336-2	1
133	Base Plate	—	1
134R	Right Base Cover (Part of Tin Assembly)	Kit 1-2340	1
135A	Air Fitting, 1/4" ARD Male Coupling 1/4" NPT	1-1788	1
136A	Air Cylinder Rodless	1-23381	1
138	Quick Release Clamp, Fusion	1-2332-1	2
142	Machine Screw M3 x 8 Long JIS Standard	—	2
143	Silicone Damper	1-2424	2
145	Cable Carrier	1-23371	1
147	Left Base Cover (Part of Tin Assembly)K	Kit 1-2340	1
148	Base Access Plate (Part of Tin Assembly)K	Kit 1-2340	1
149	Foot Pedal Socket (Part of Foot Pedal Assembly)	Kit 1-2305	1
150	Air Fitting, Elbow Bulkhead 1/4" Tube	—	1
152	Screw, Machine #8-32 x 1/2"	3-1011-159	6
153	Screw, Button Head Socket 1/4"-20 x 1/2"	3-1011-246	12
154	Screw, Machine #6-32 x 1/4"	3-1011-25	12
155	Nut, Hex #8-32 w/ Tooth Washer	2-1006-52	8
156	Screw, Machine #4-40 x 3/8"	3-1011-22	9
157	Screw, Machine #8-32 x 3/8" Black Oxide3	3-1011-127	4
158	Screw, Socket Head 1/4"-20 x 1-3/4"	3-1011-194	6
159	Screw, Socket Head M4 x 20mm	1-2426	38
160	Power Inlet and Filter, 20A	1-2490	1
161	Power Switch	1-2087	1
162	Circuit Breaker 20A (STX XF XRF)	1-13312	1
163	Dual Fusion Carriage Plate	1-2344	1
164	Block, XRF2 (not sold separately)	—	4
167	Drive Angle	1-2341	2
168	Screw, Flat Head Phillips 1/4"-20 x 1/2"	—	4
169	Hard Stop	1-2343	2
170	Dual Fusion Magnet Bracket	1-2425	2
171	Screw, Machine #4-40 x 1/4"	3-1011-15	4
172	Proximity Switch	1-1211	2
173	Nut, #4-40 with Tooth Washer	2-1006-51	4
174	Screw, Socket Head M5 x 15mm3	3-1011-263	16
174	Foot Pedal AssemblyK	Kit 1-2305	1
178	Power Cord C19 250V	1-2353	1

• Verschleißteile/Wear Parts

Parts Location Guide

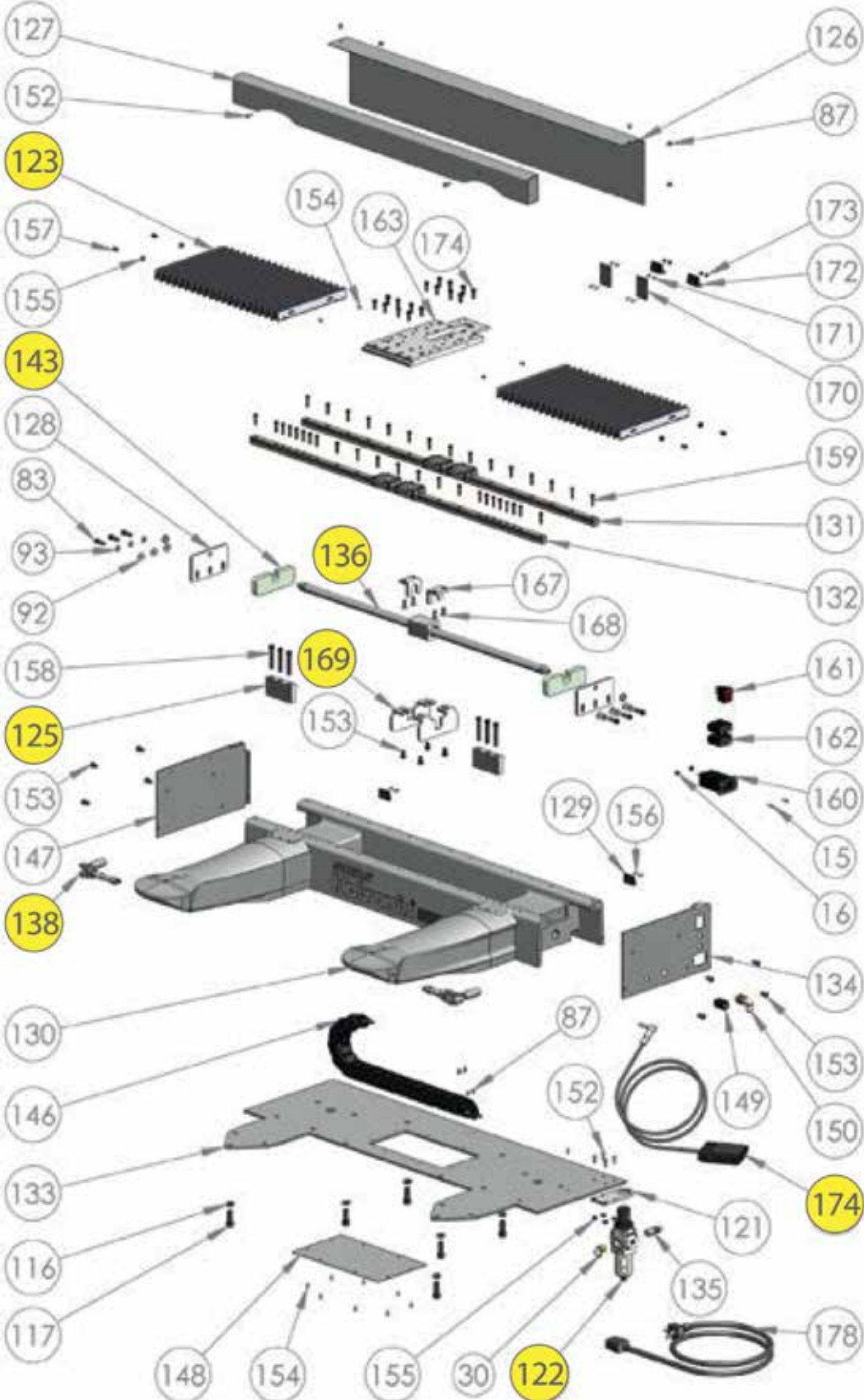

 = Verschleißteile/Wear Parts

CONTACT US

STAHL'S' Europe GmbH

Dieselstraße 62
66763 Dillingen
Germany

Technical Support & Customer Service

+49 (0) 68 31/97 33 0

Email

info@stahls.de

Web

stahls.de

STAHL'S'
EUROPE • AFRICA • MID EAST

This document includes multiple trademarks and describes equipment covered by many patents that are owned by GroupeSTAHL and/or its subsidiaries. GroupeSTAHL enforces its rights to protect these intellectual properties. ©2018